

Figure 8.1b
Biochemistry: A Short Course, Second Edition
 © 2013 W. H. Freeman and Company

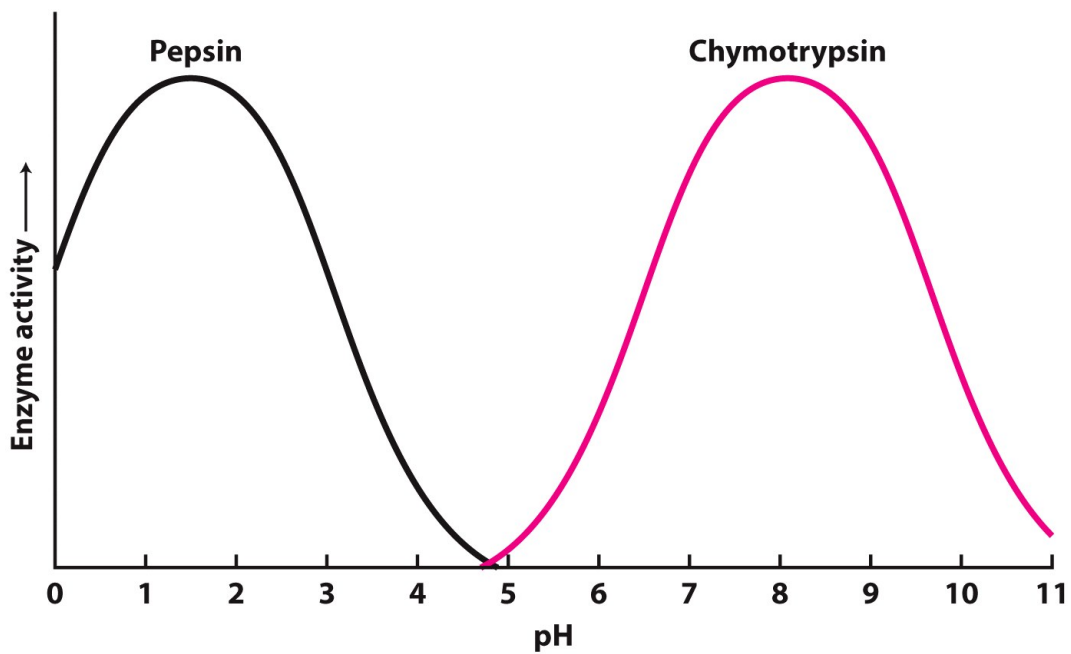

Figure 8.4
Biochemistry: A Short Course, Second Edition
 © 2013 W. H. Freeman and Company

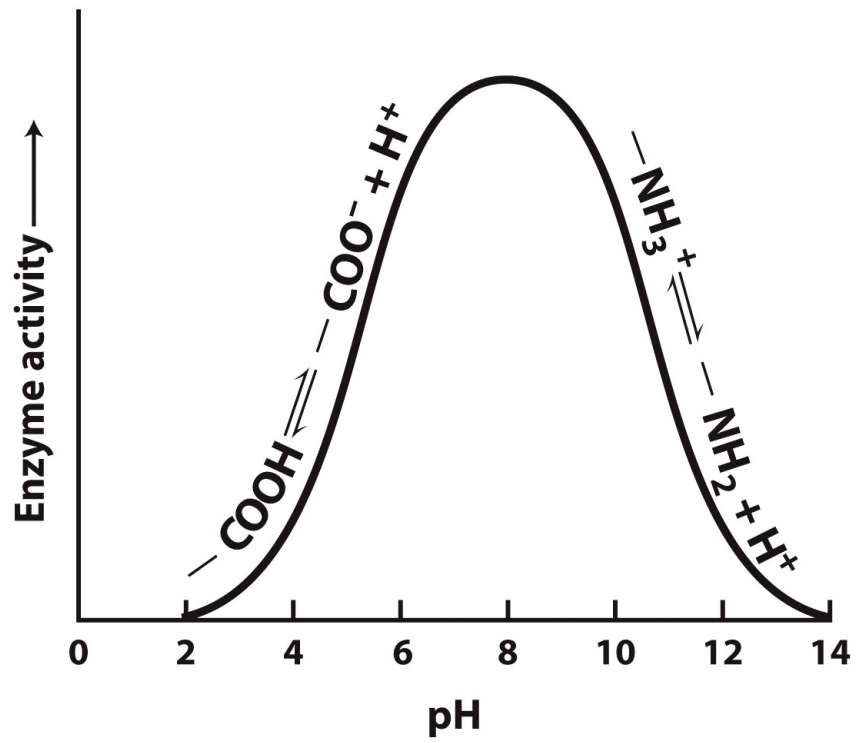

Figure 8.5
Biochemistry: A Short Course, Second Edition
 © 2013 W. H. Freeman and Company

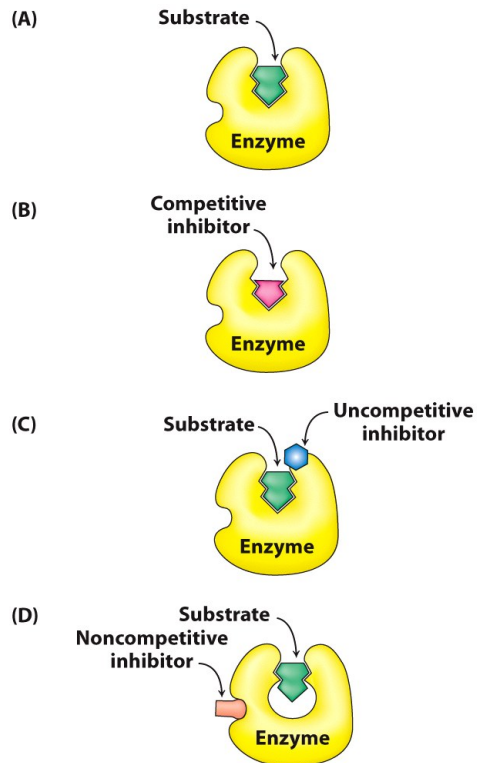
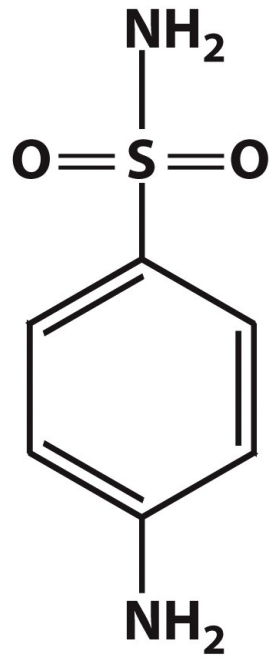
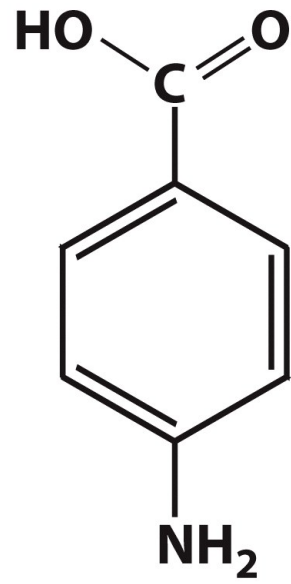

Figure 8.6
Biochemistry: A Short Course, Second Edition
 © 2013 W. H. Freeman and Company



Sulfanilamide



PABA

Unnumbered 8 p128
 Biochemistry: A Short Course, Second Edition
 © 2013 W. H. Freeman and Company

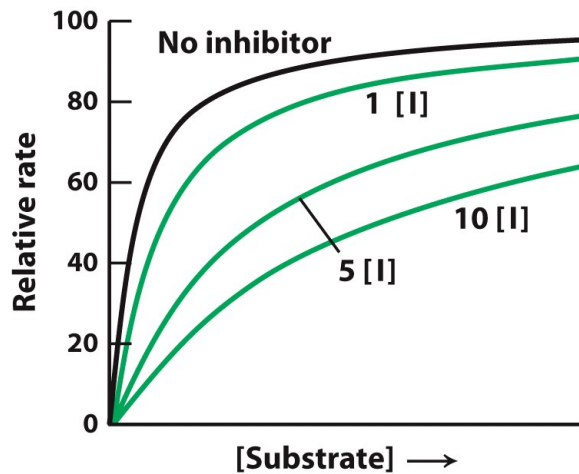
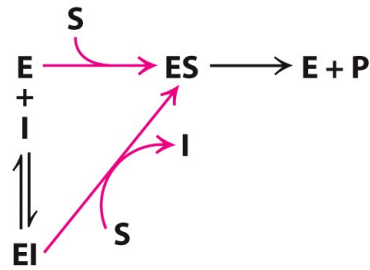

Figure 8.7
 Biochemistry: A Short Course, Second Edition
 © 2013 W. H. Freeman and Company

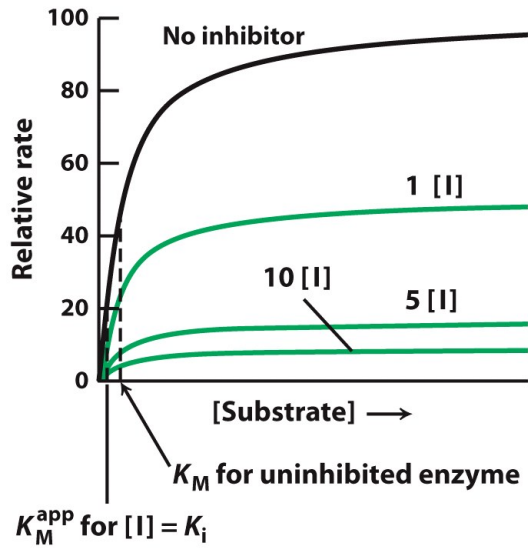
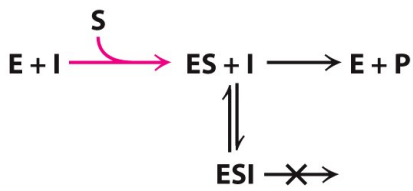

Figure 8.8
Biochemistry: A Short Course, Second Edition
 © 2013 W. H. Freeman and Company

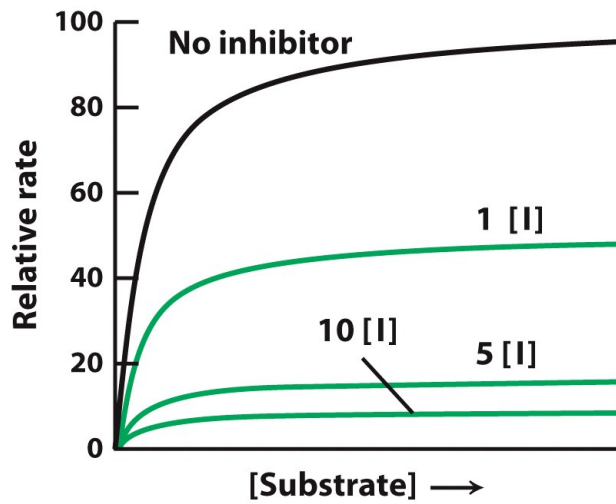
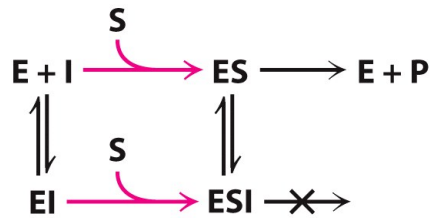
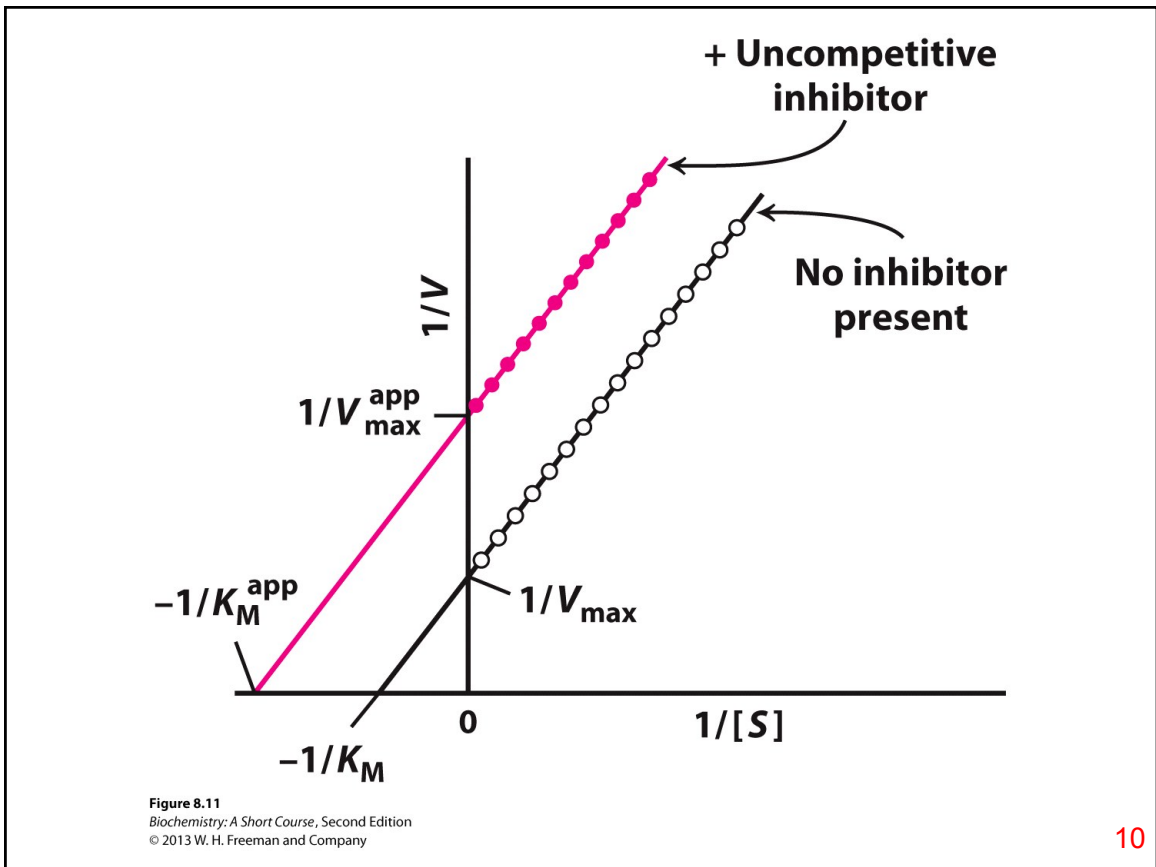
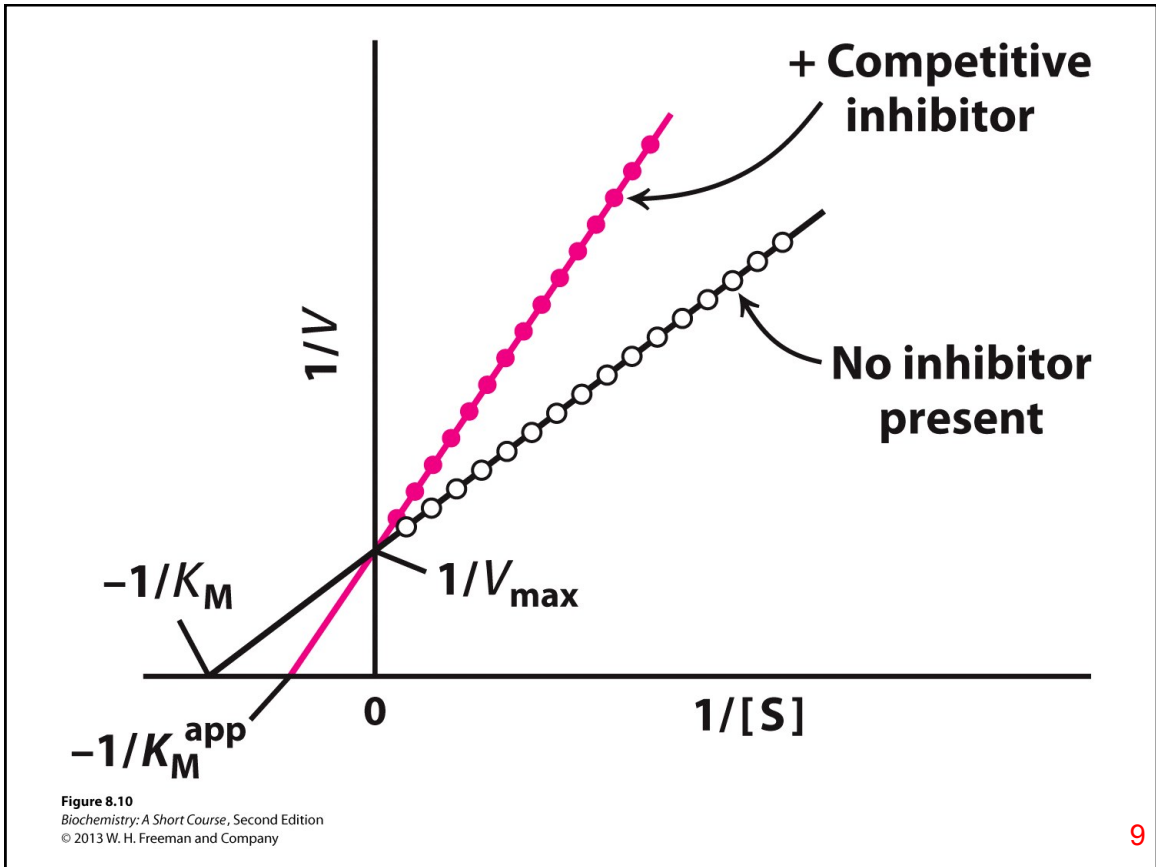
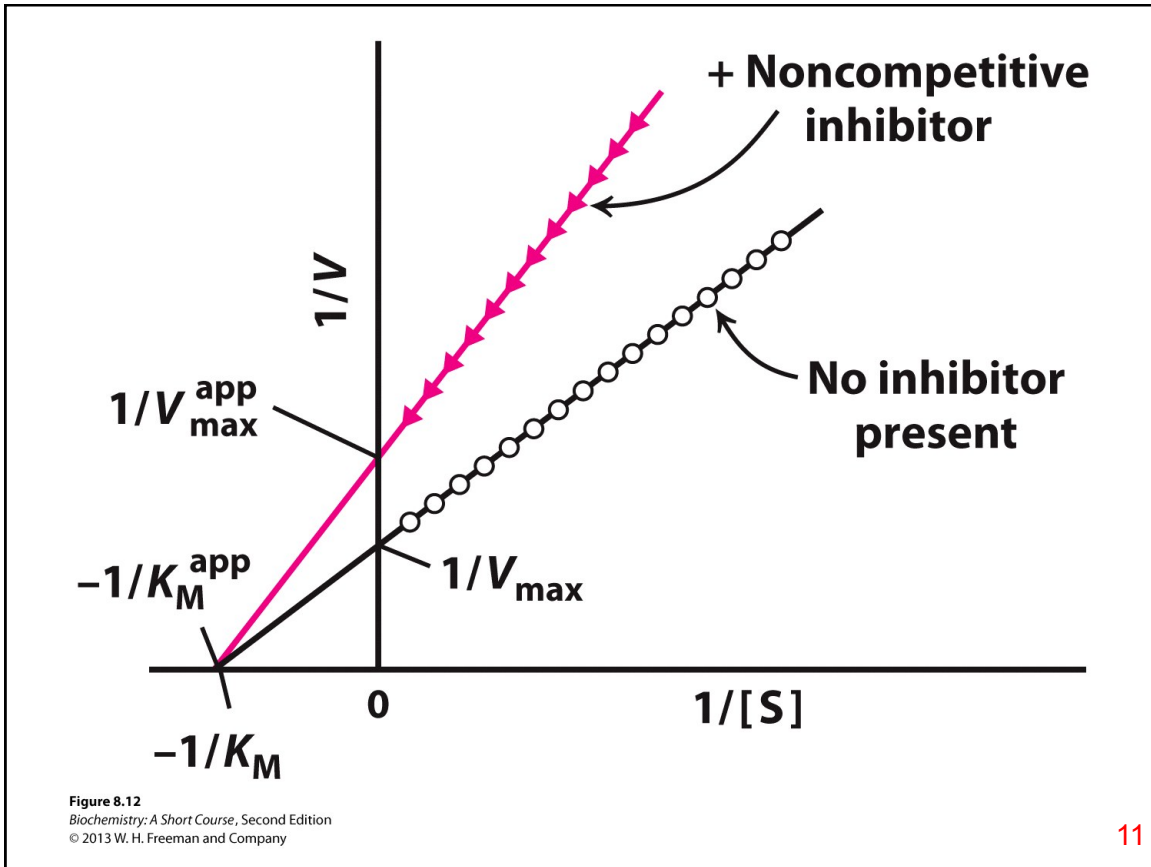
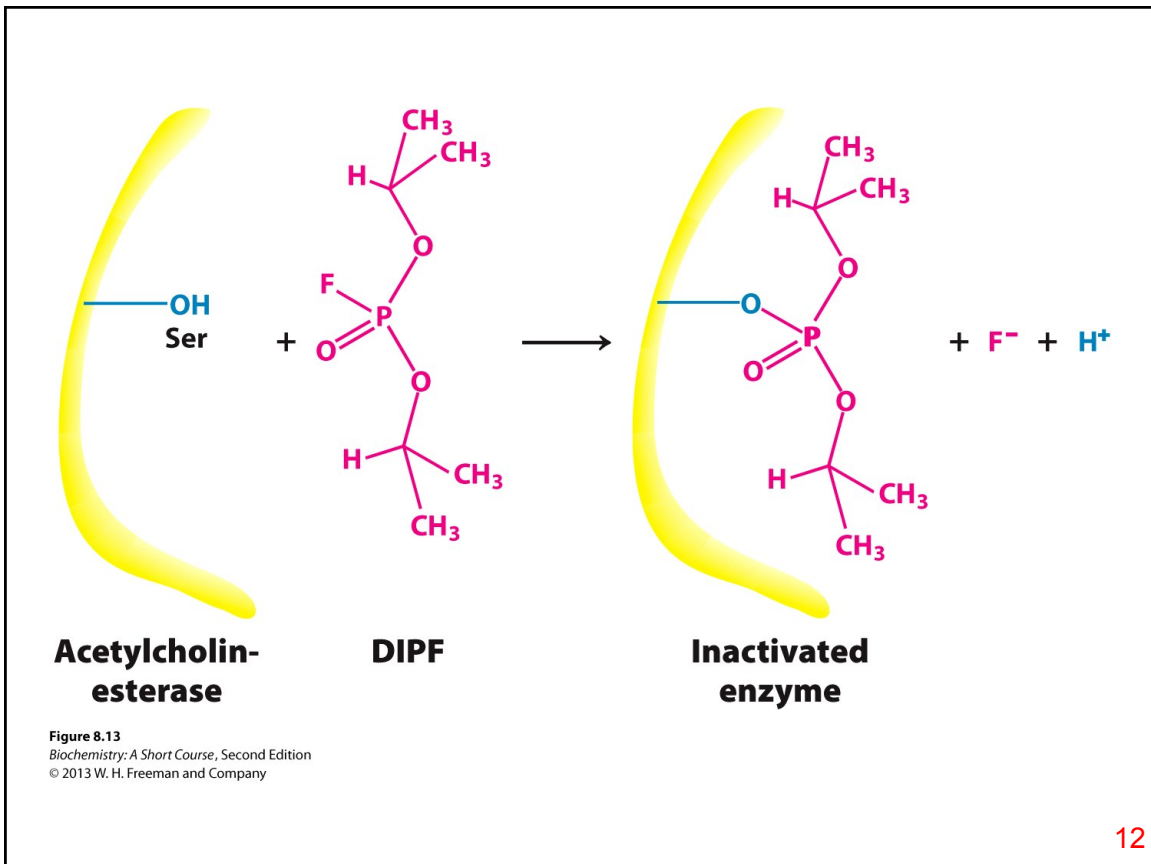

Figure 8.9
Biochemistry: A Short Course, Second Edition
 © 2013 W. H. Freeman and Company





11



12

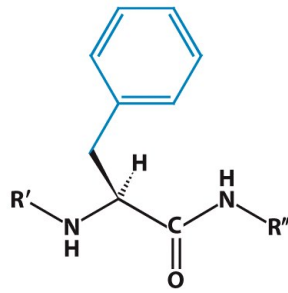

Natural substrate for chymotrypsin

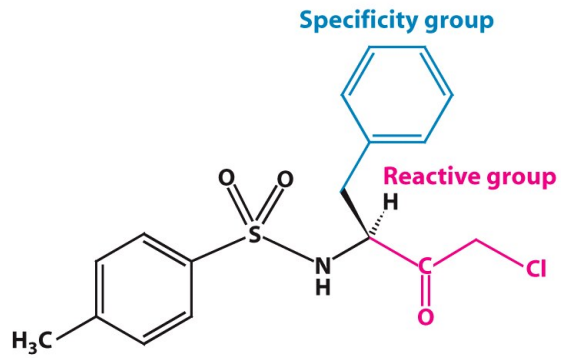

Tosyl-L-phenylalanine chloromethyl ketone (TPCK)

Figure 8.14a
Biochemistry: A Short Course, Second Edition
 © 2013 W. H. Freeman and Company

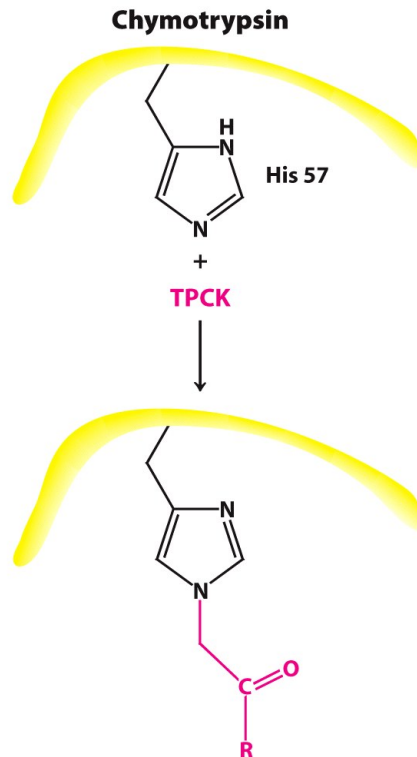

Figure 8.14b
Biochemistry: A Short Course, Second Edition
 © 2013 W. H. Freeman and Company

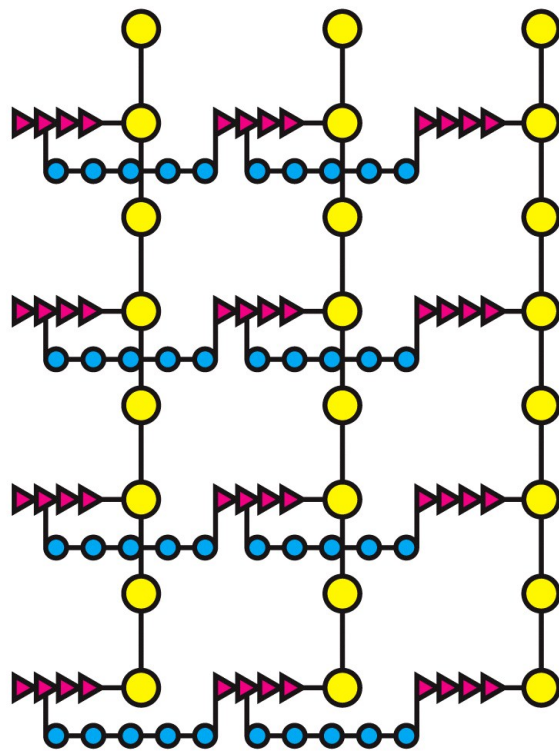

Figure 8.16
Biochemistry: A Short Course, Second Edition
 © 2013 W. H. Freeman and Company

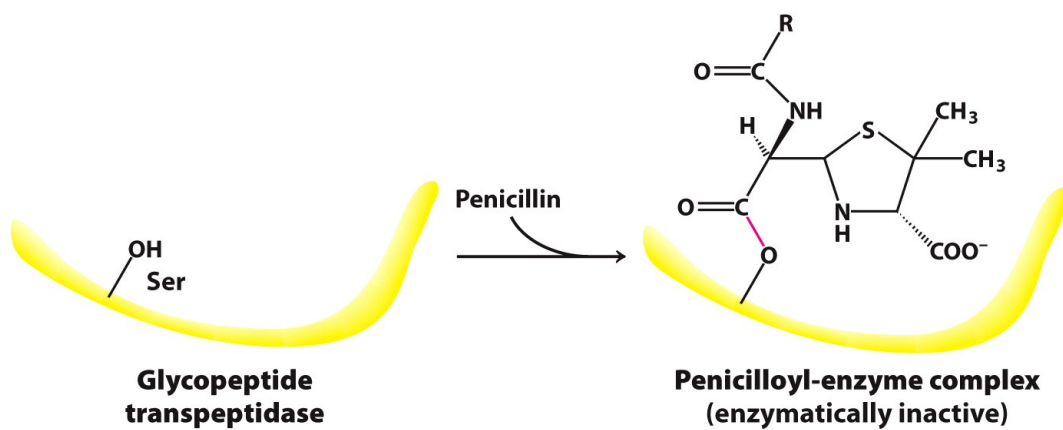

Figure 8.19
Biochemistry: A Short Course, Second Edition
 © 2013 W. H. Freeman and Company

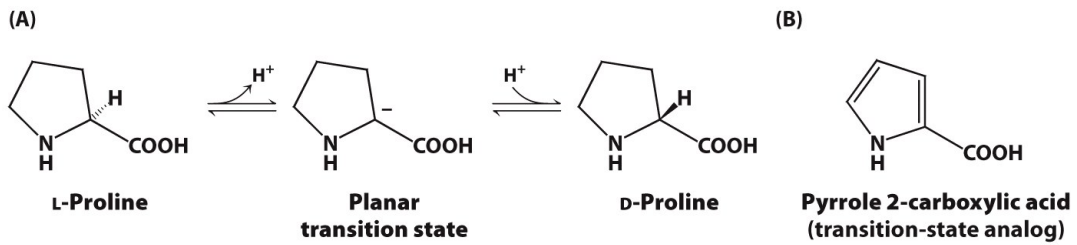

Figure 6.7
Biochemistry: A Short Course, Second Edition
 © 2013 W. H. Freeman and Company