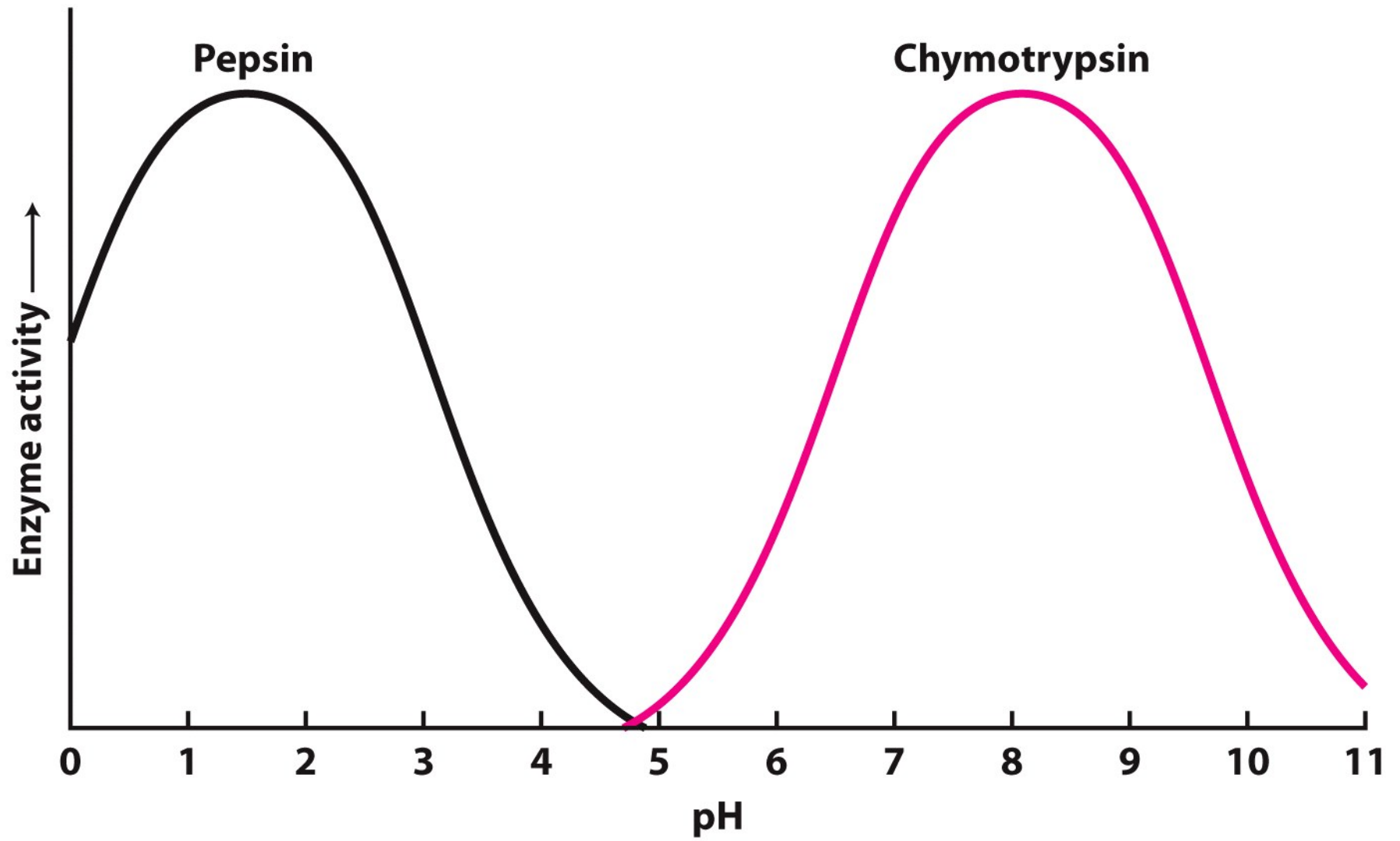
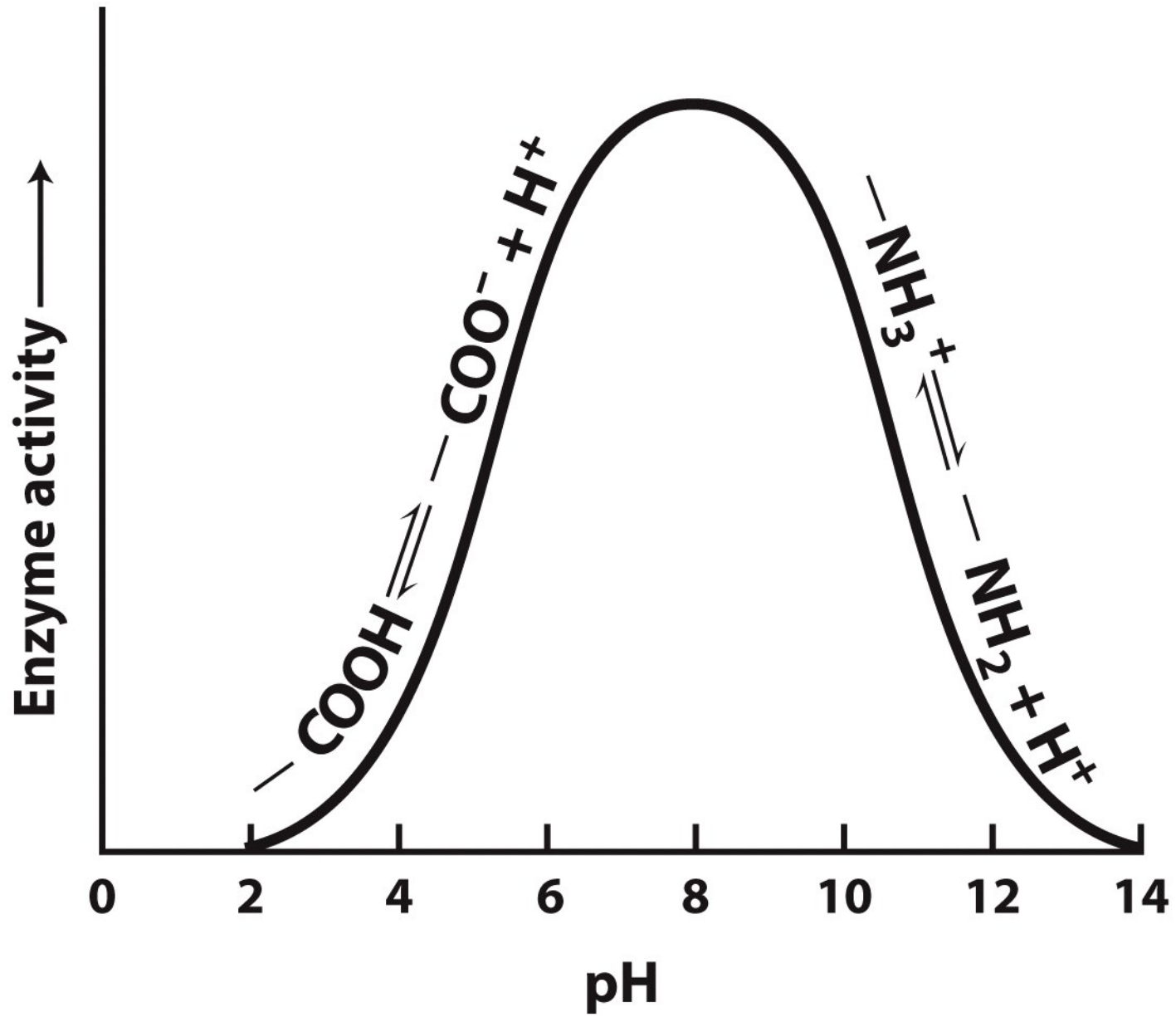


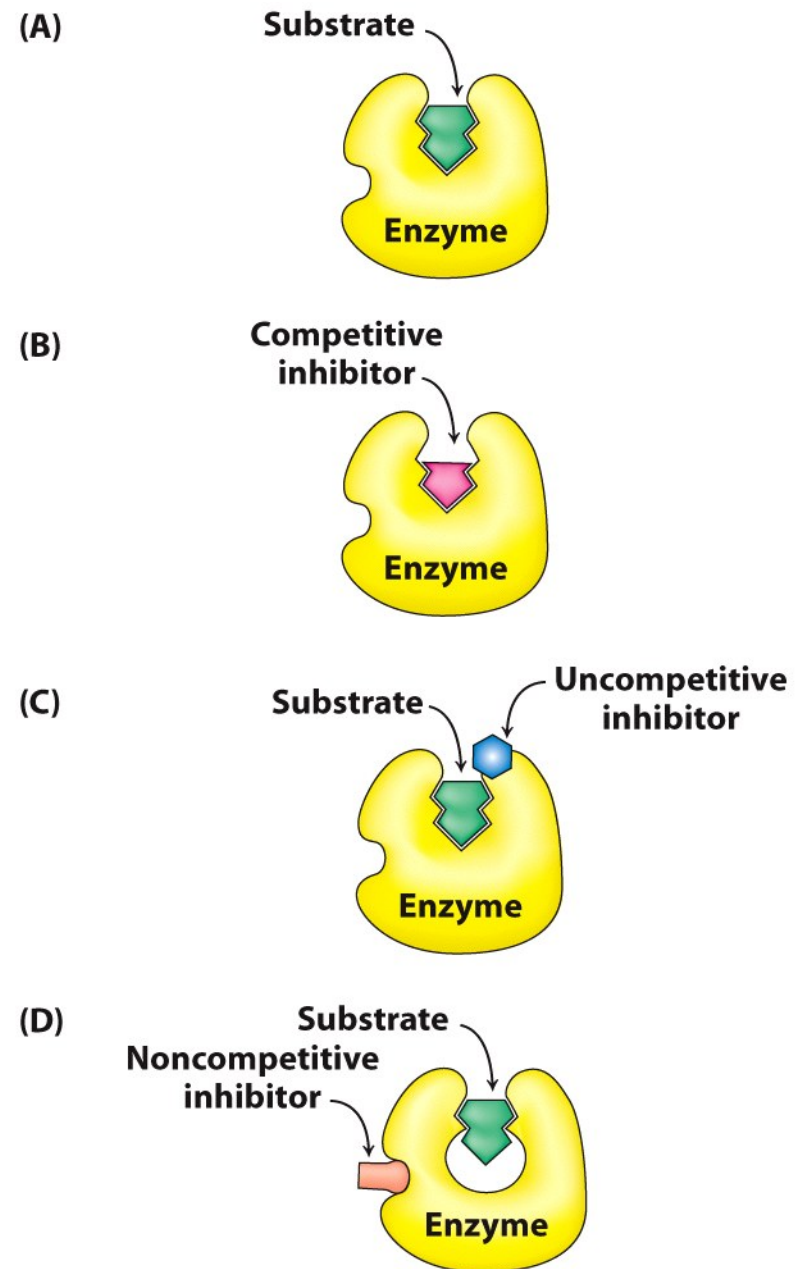
**Figure 8.1b**  
*Biochemistry: A Short Course, Second Edition*  
© 2013 W. H. Freeman and Company



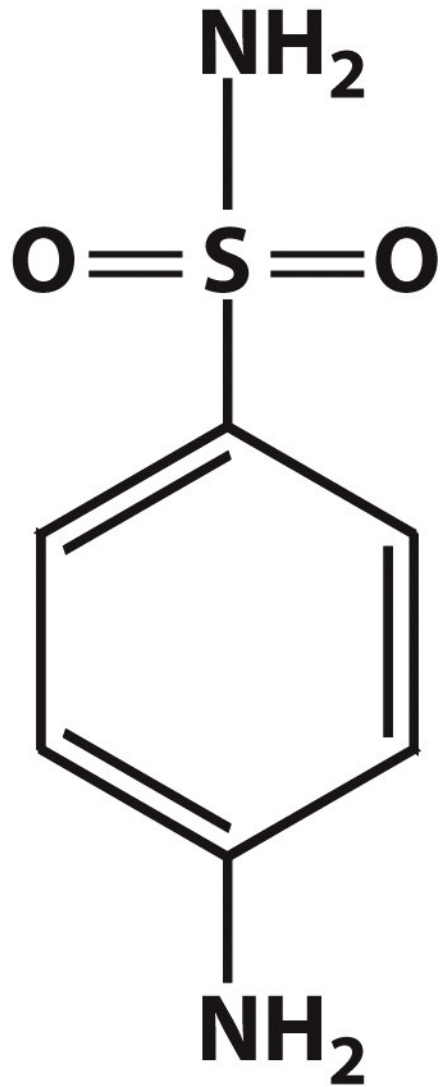
**Figure 8.4**  
*Biochemistry: A Short Course, Second Edition*  
© 2013 W. H. Freeman and Company



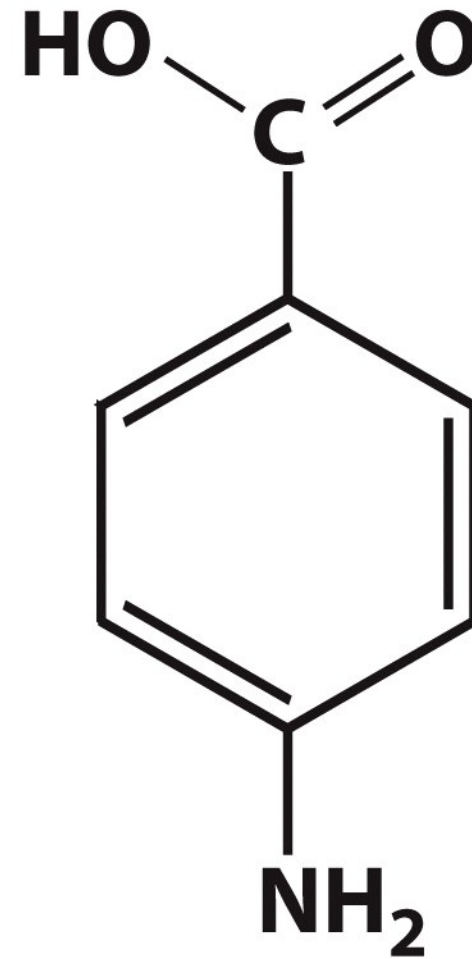
**Figure 8.5**  
*Biochemistry: A Short Course, Second Edition*  
 © 2013 W. H. Freeman and Company



**Figure 8.6**  
*Biochemistry: A Short Course, Second Edition*  
© 2013 W. H. Freeman and Company



**Sulfanilamide**

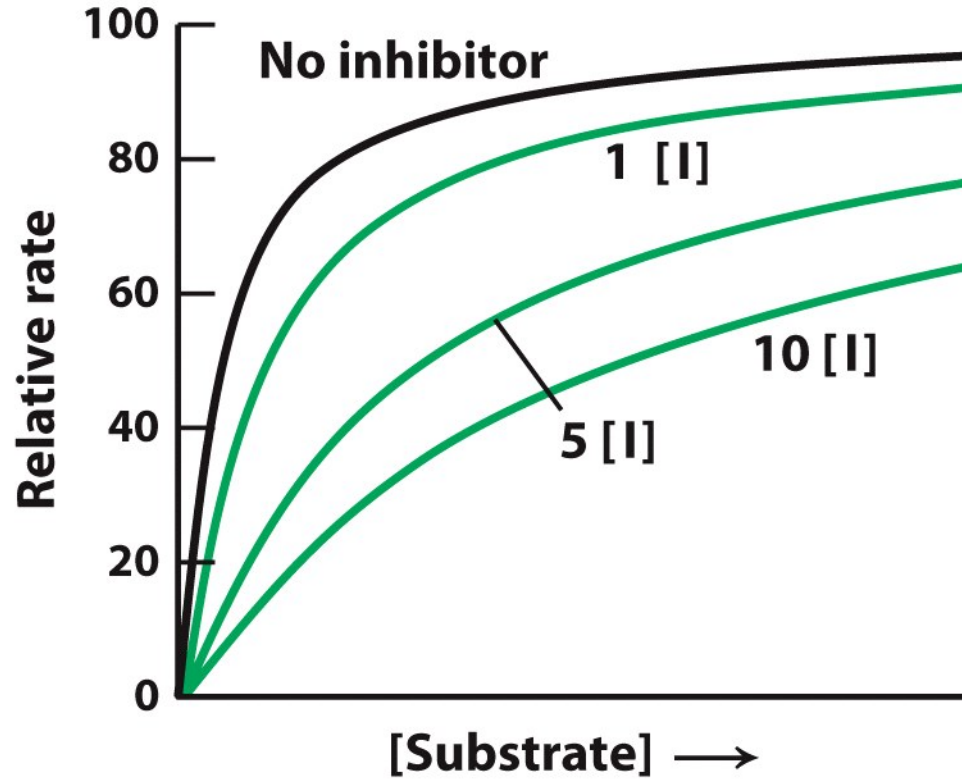
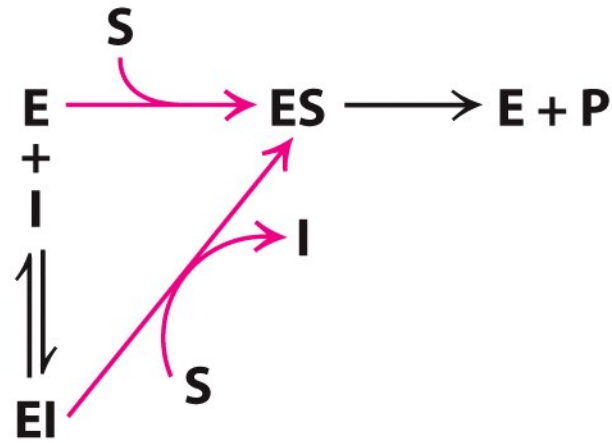


**PABA**

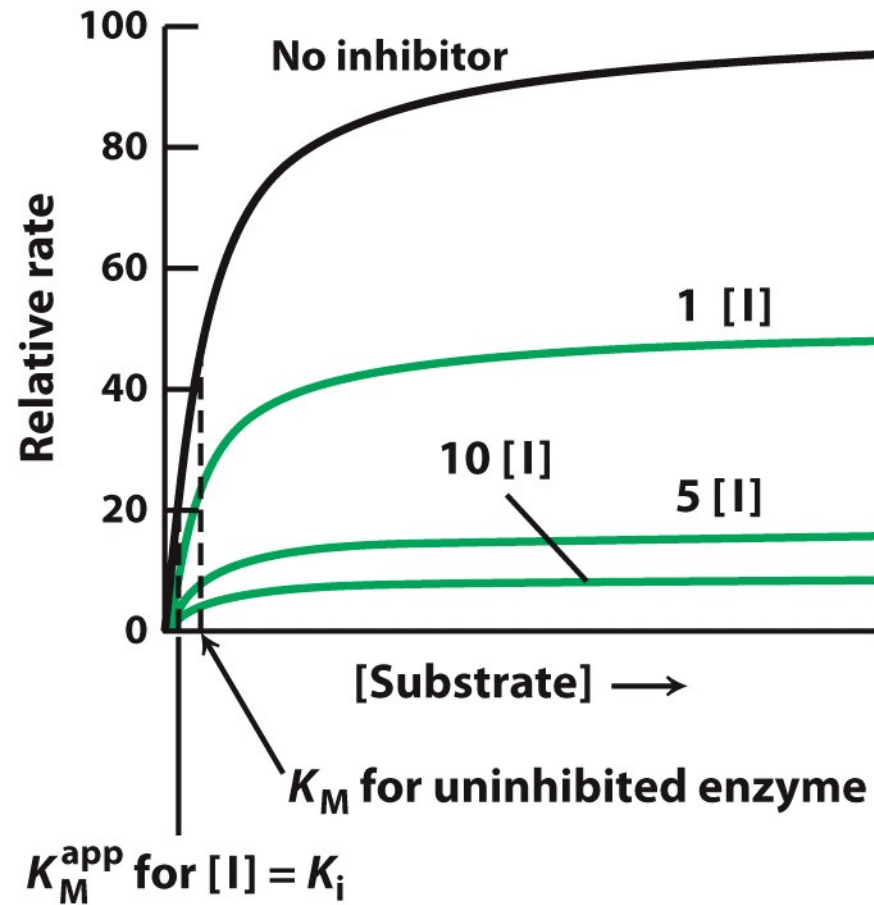
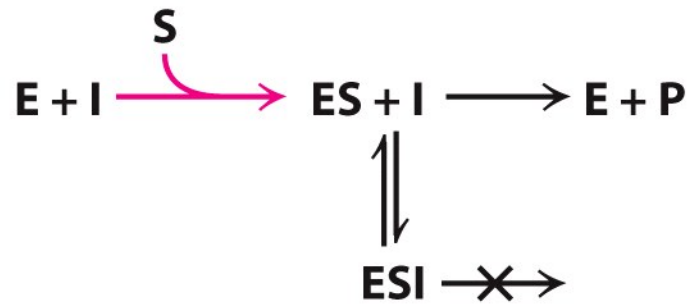
Unnumbered 8 p128

*Biochemistry: A Short Course, Second Edition*

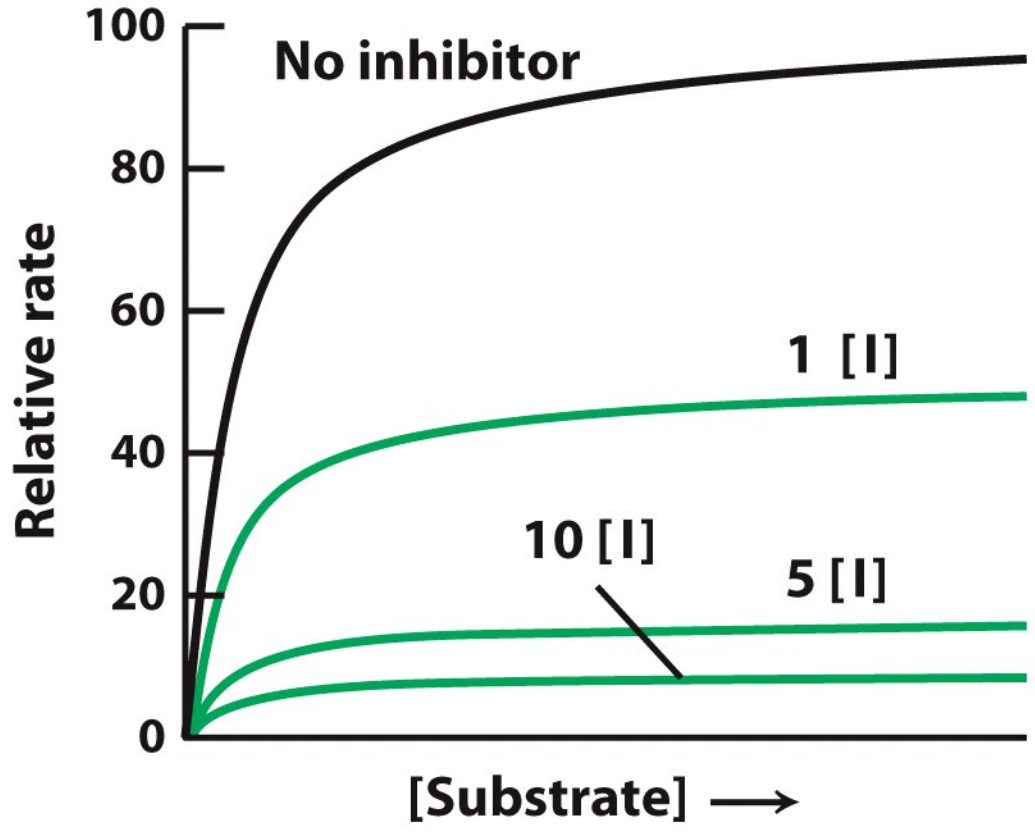
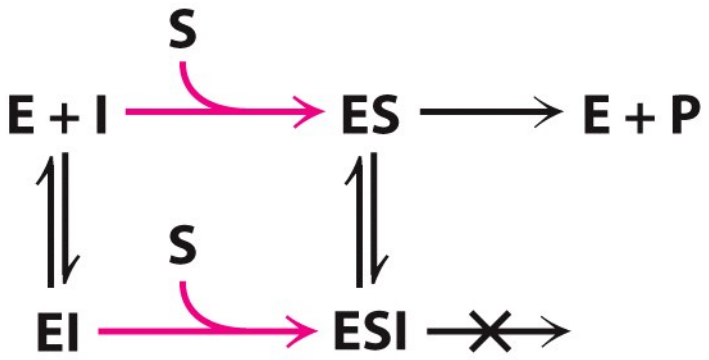
© 2013 W. H. Freeman and Company



**Figure 8.7**  
*Biochemistry: A Short Course, Second Edition*  
 © 2013 W. H. Freeman and Company

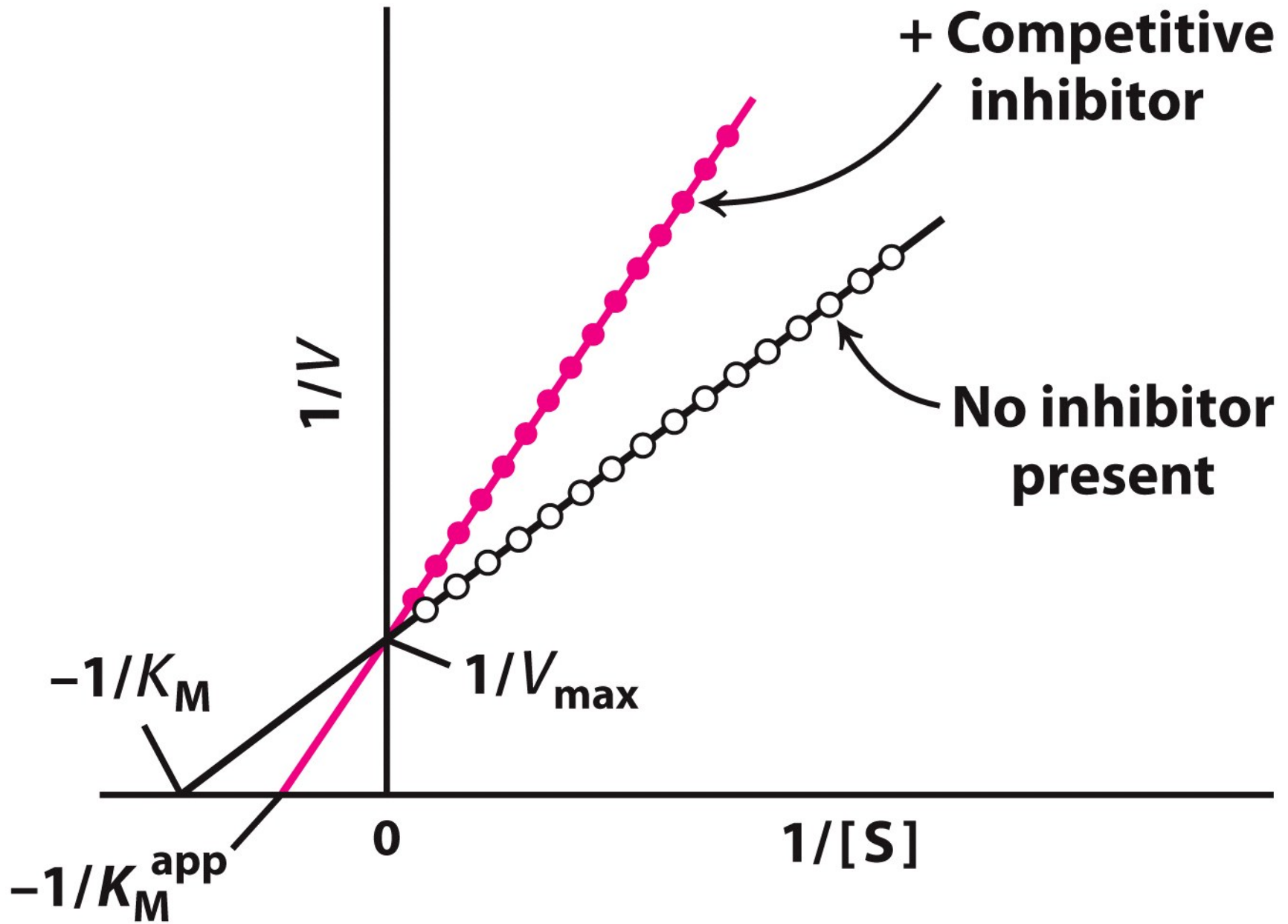


**Figure 8.8**  
*Biochemistry: A Short Course, Second Edition*  
 © 2013 W. H. Freeman and Company

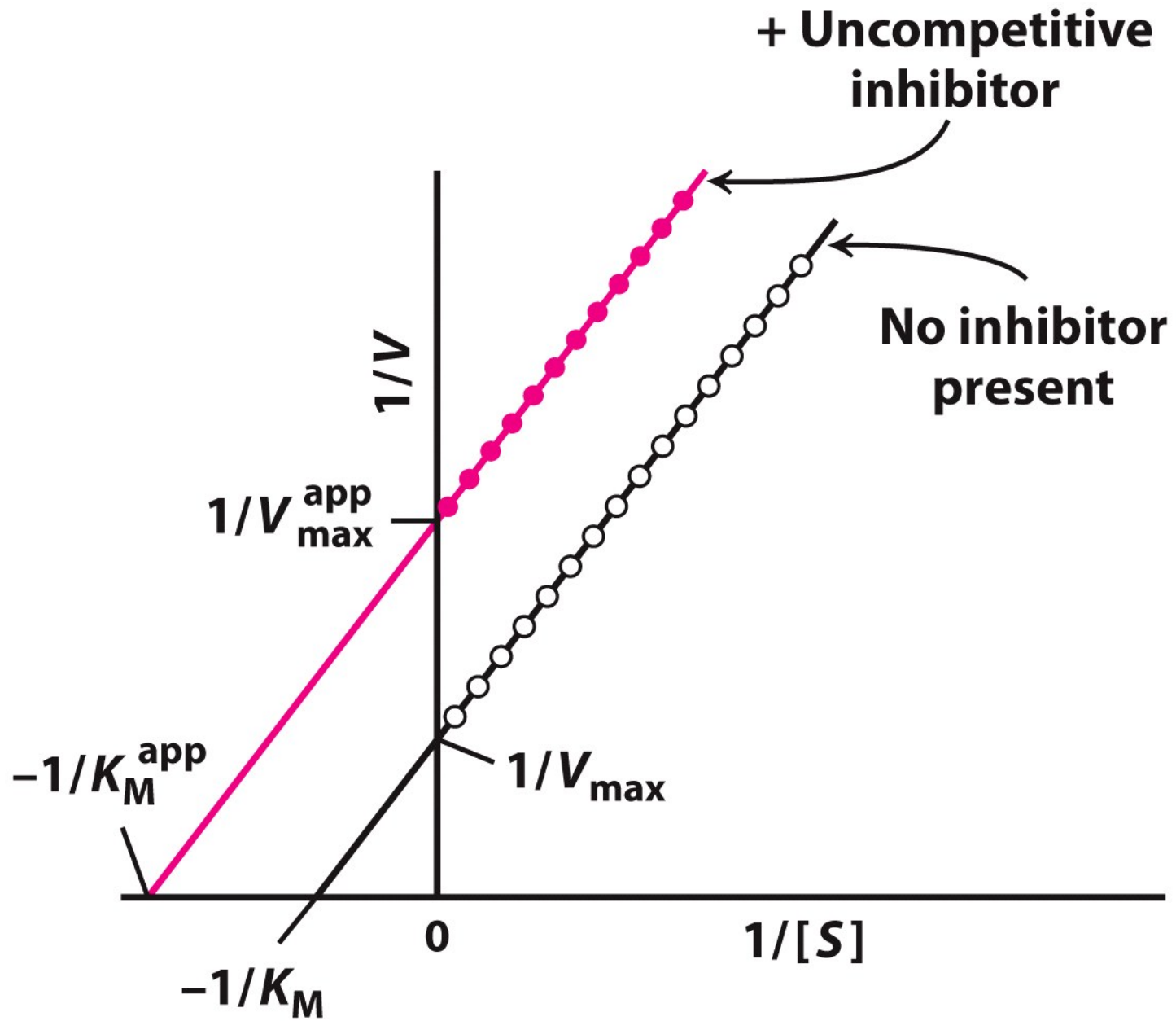


**Figure 8.9**  
*Biochemistry: A Short Course, Second Edition*  
 © 2013 W. H. Freeman and Company

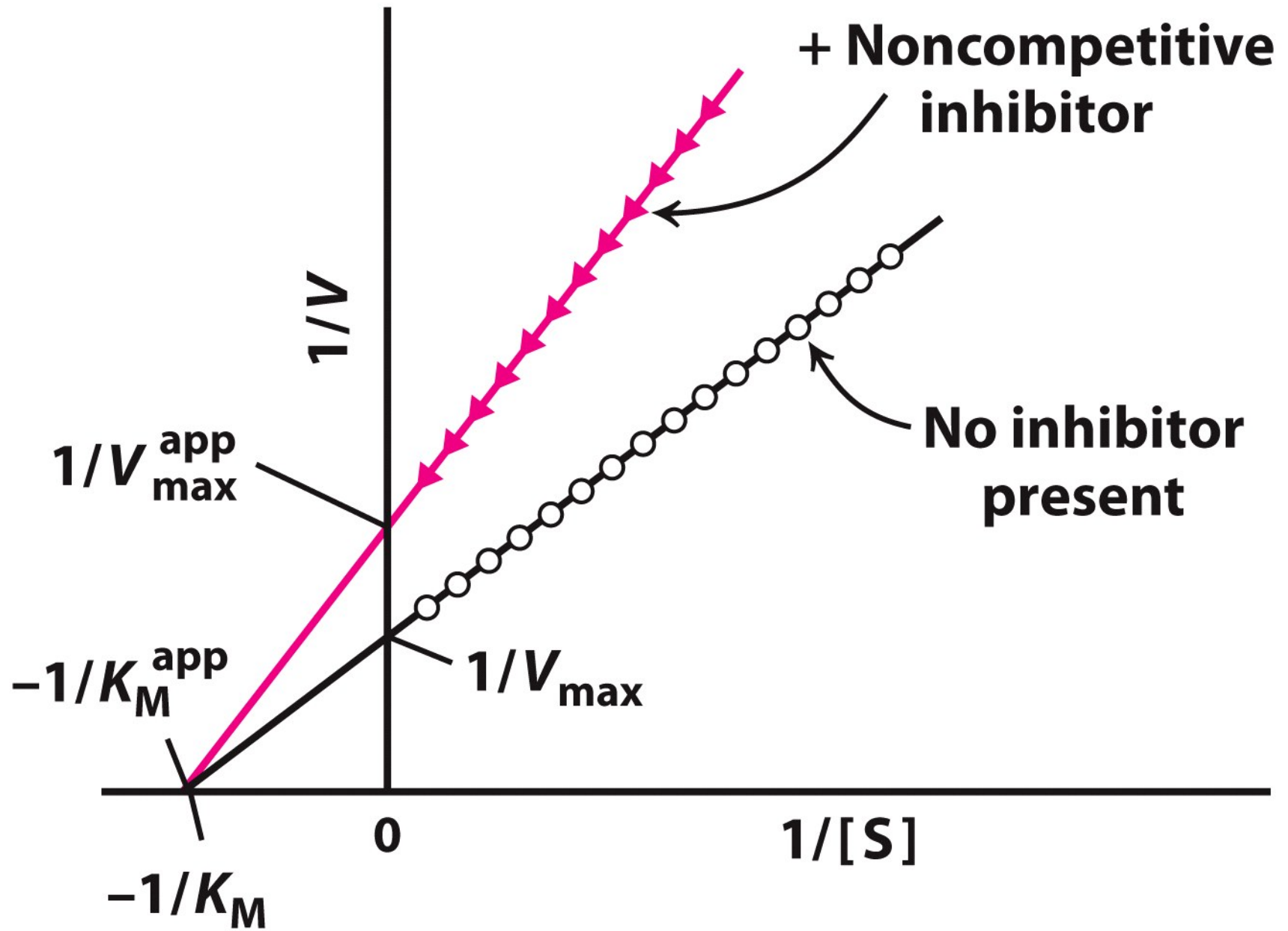




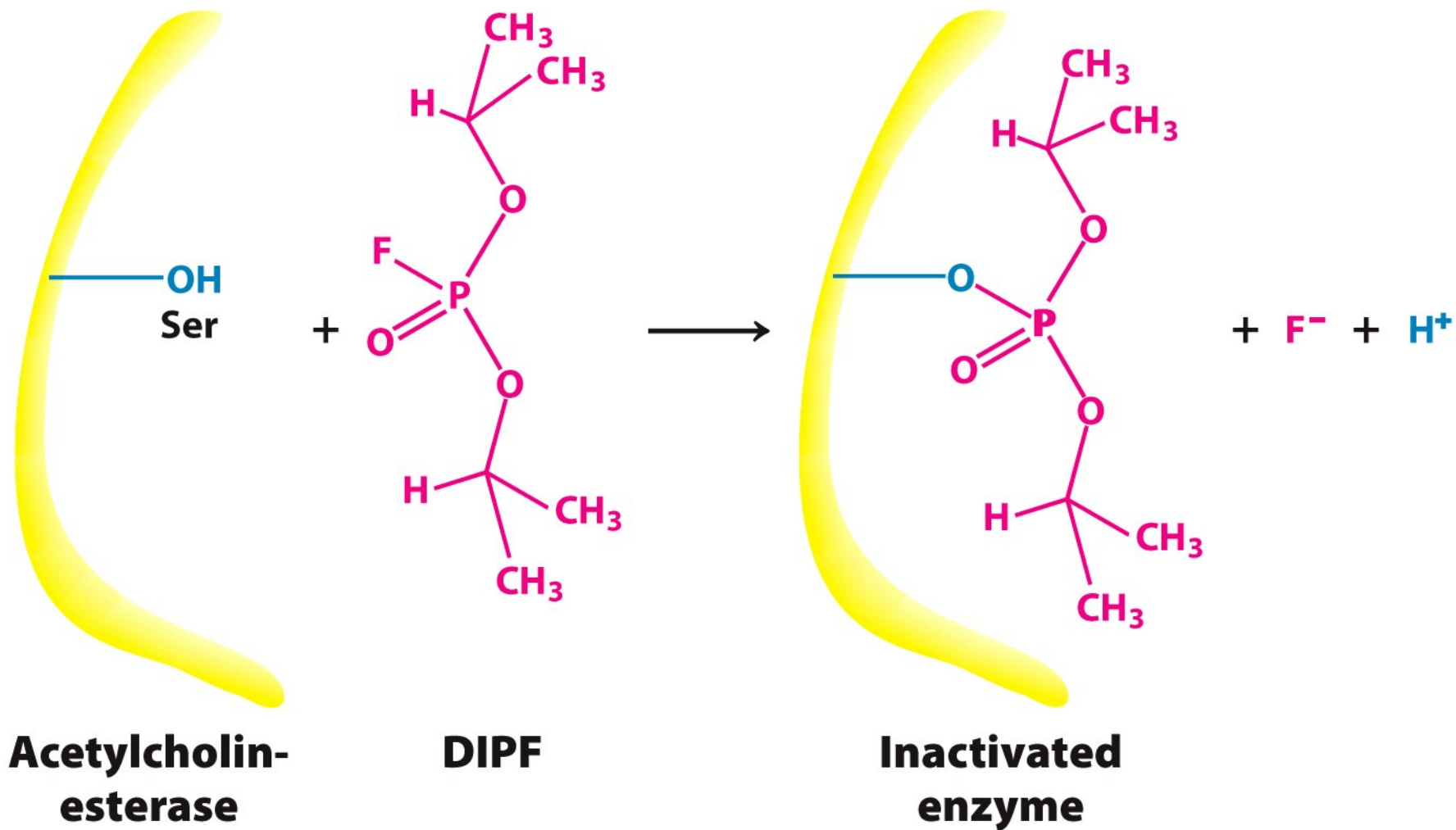
**Figure 8.10**  
*Biochemistry: A Short Course, Second Edition*  
 © 2013 W. H. Freeman and Company



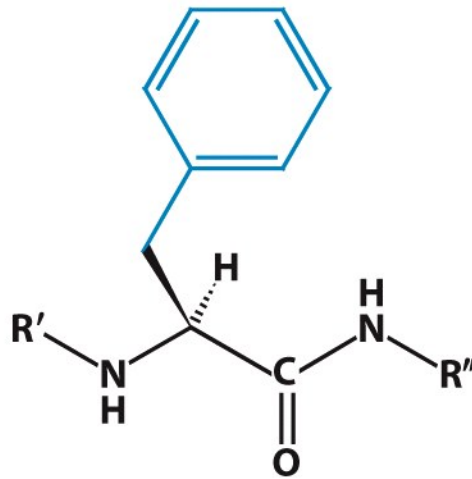
**Figure 8.11**  
*Biochemistry: A Short Course, Second Edition*  
 © 2013 W. H. Freeman and Company



**Figure 8.12**  
*Biochemistry: A Short Course, Second Edition*  
 © 2013 W. H. Freeman and Company

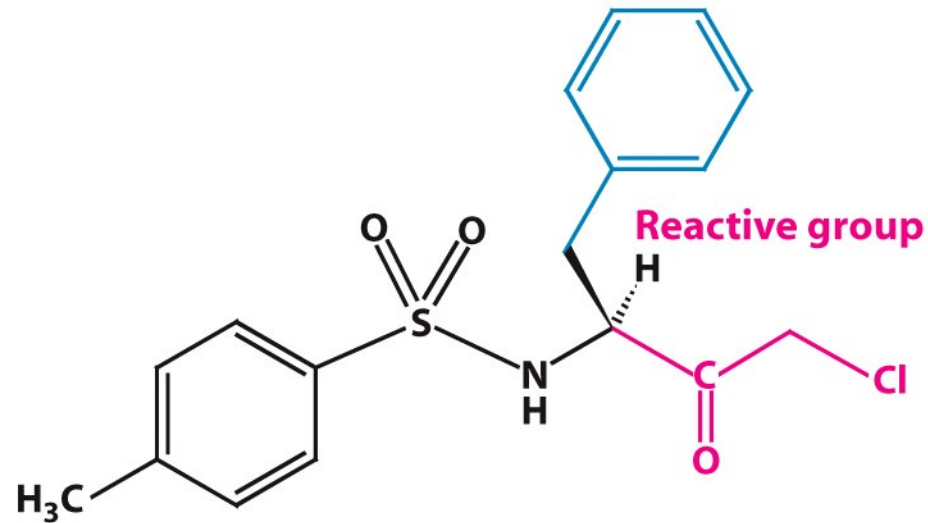


**Figure 8.13**  
*Biochemistry: A Short Course, Second Edition*  
 © 2013 W. H. Freeman and Company



**Natural substrate for chymotrypsin**

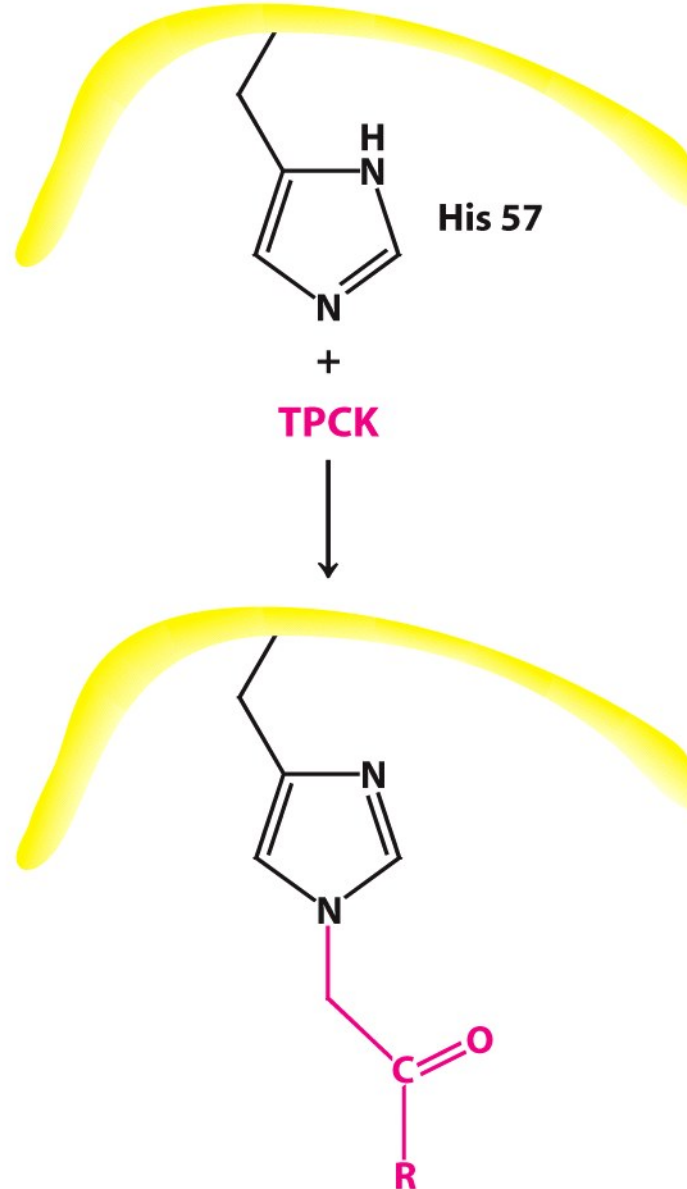
Specificity group



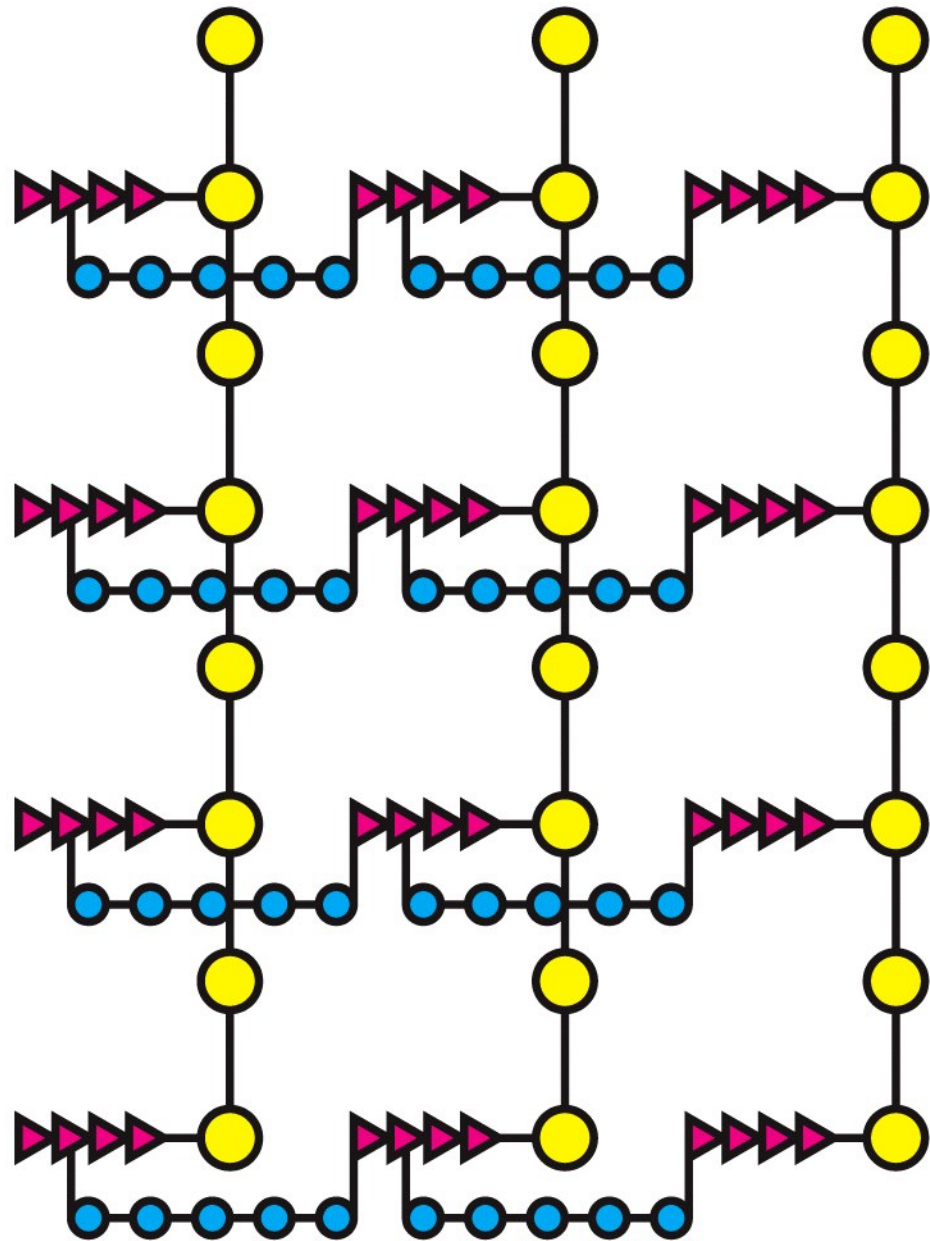
**Tosyl-L-phenylalanine chloromethyl ketone (TPCK)**

**Figure 8.14a**  
*Biochemistry: A Short Course, Second Edition*  
© 2013 W. H. Freeman and Company

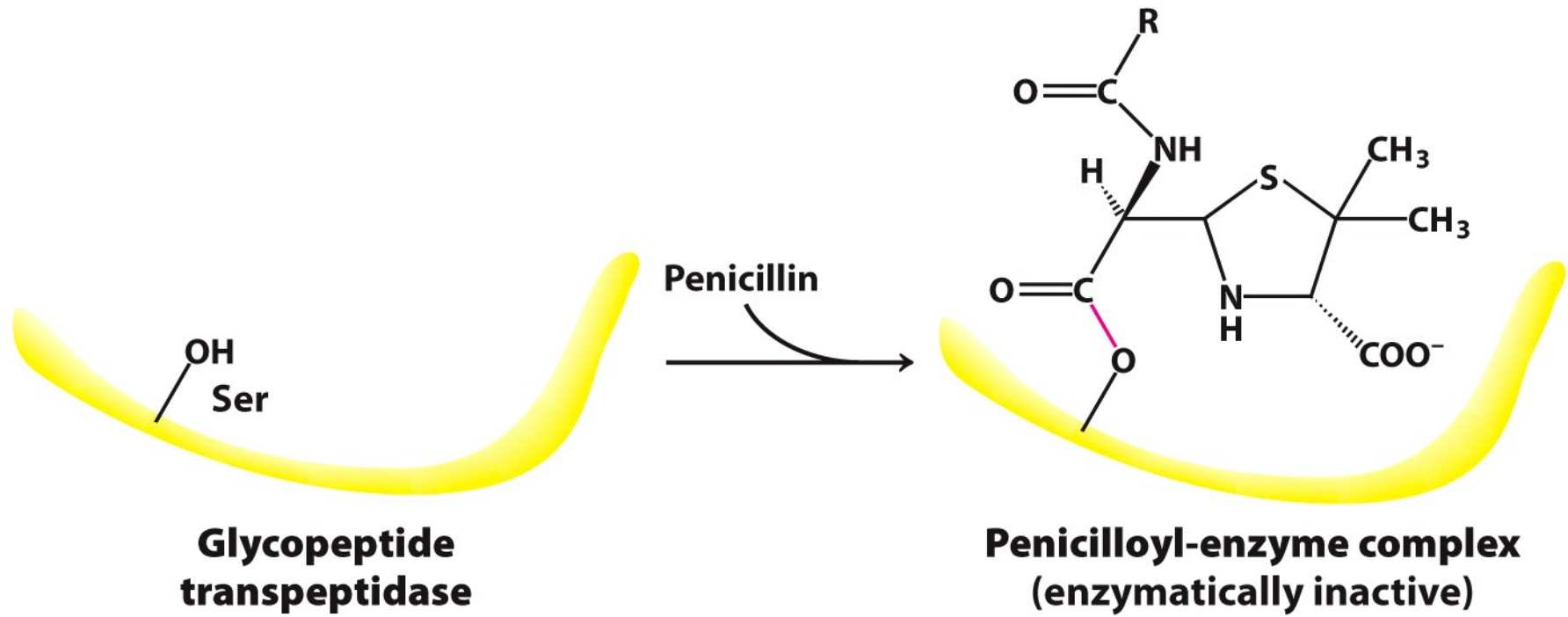
# Chymotrypsin



**Figure 8.14b**  
*Biochemistry: A Short Course, Second Edition*  
© 2013 W. H. Freeman and Company

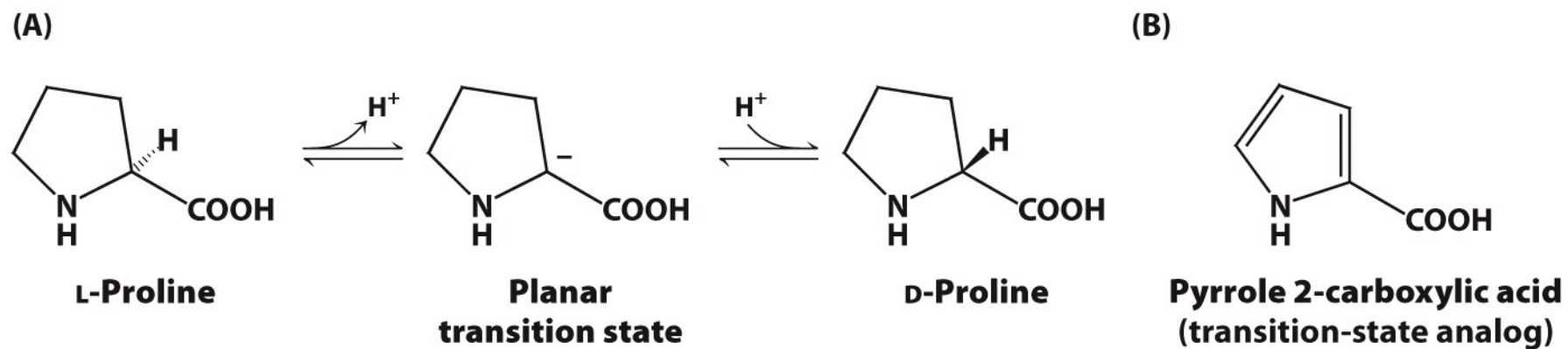


**Figure 8.16**  
*Biochemistry: A Short Course, Second Edition*  
© 2013 W. H. Freeman and Company



**Figure 8.19**  
*Biochemistry: A Short Course*, Second Edition  
 © 2013 W. H. Freeman and Company





**Figure 6.7**  
*Biochemistry: A Short Course, Second Edition*  
 © 2013 W. H. Freeman and Company